

SAGINAW CONTROL & ENGINEERING

SCE-60EL4818FSD

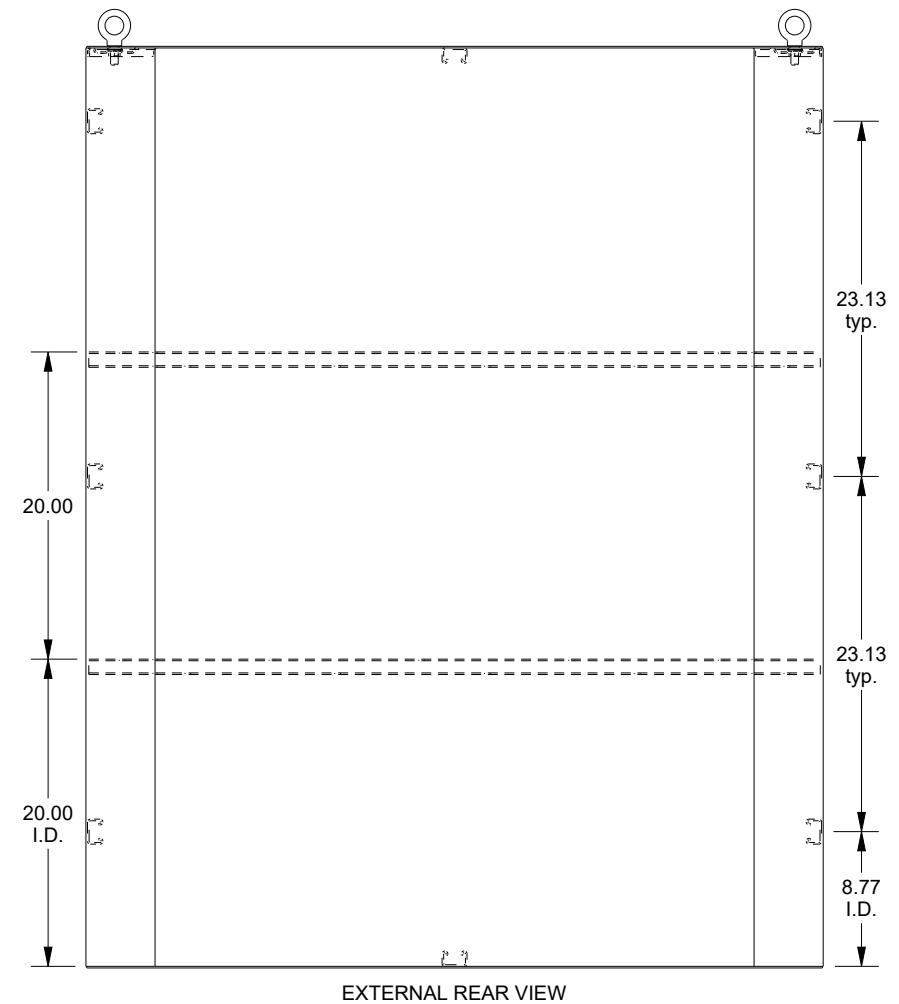

WASH SYSTEM 2" SQUARE DRAIN HOLES IN THE
BOTTOM WITH UL APPROVED HOLE SEALS PROVIDED

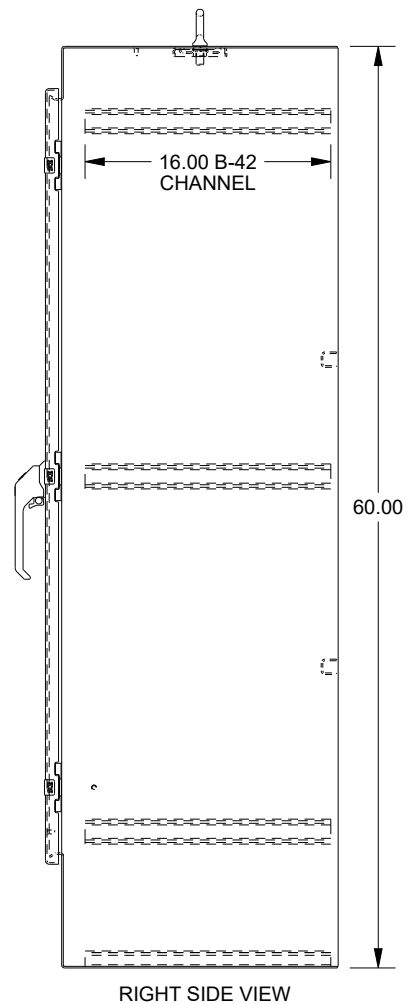
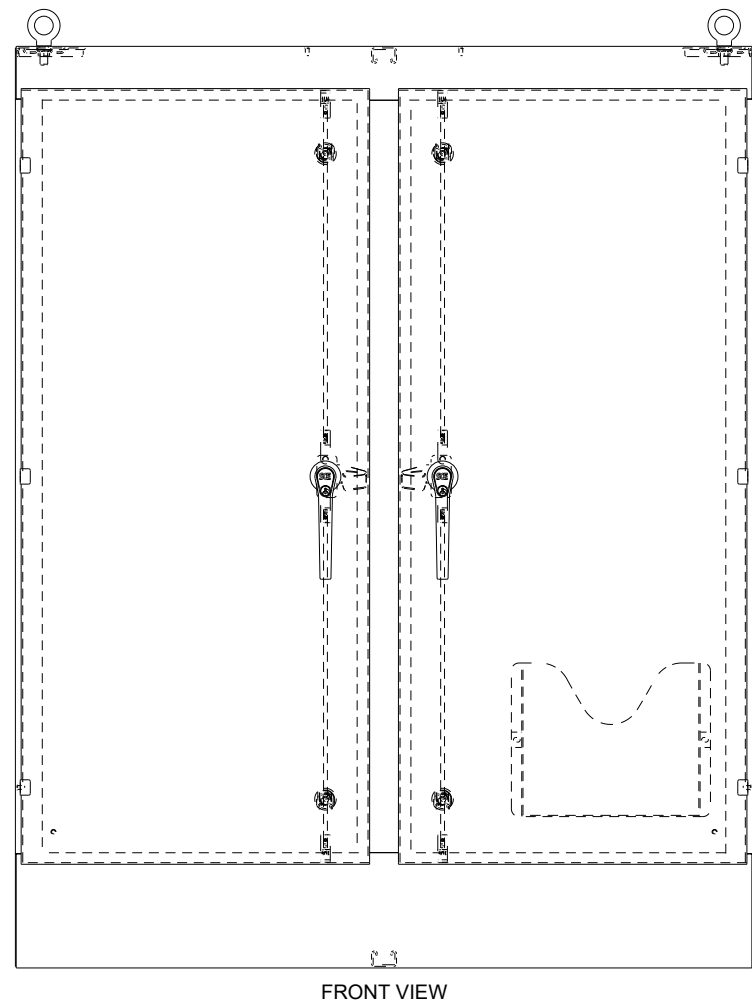
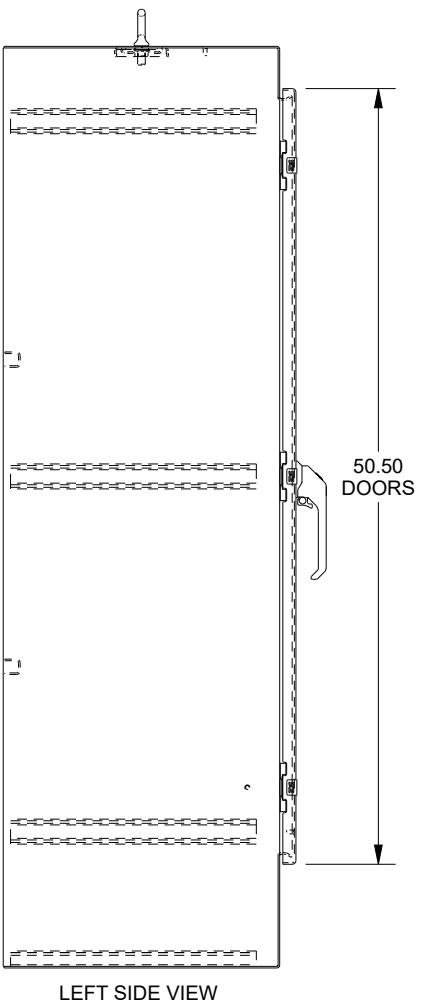
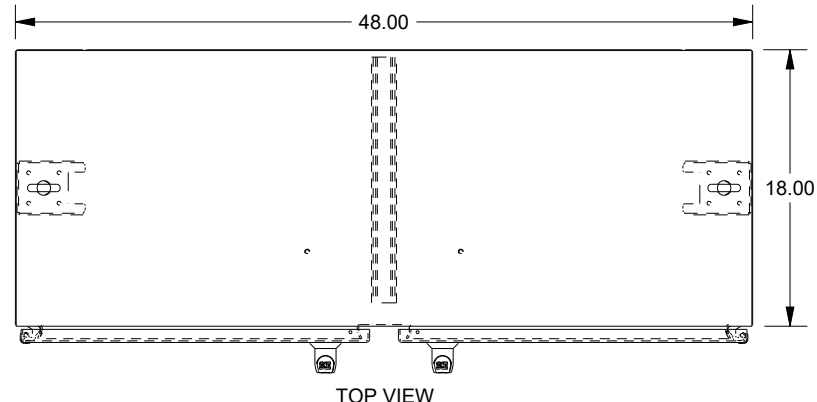